

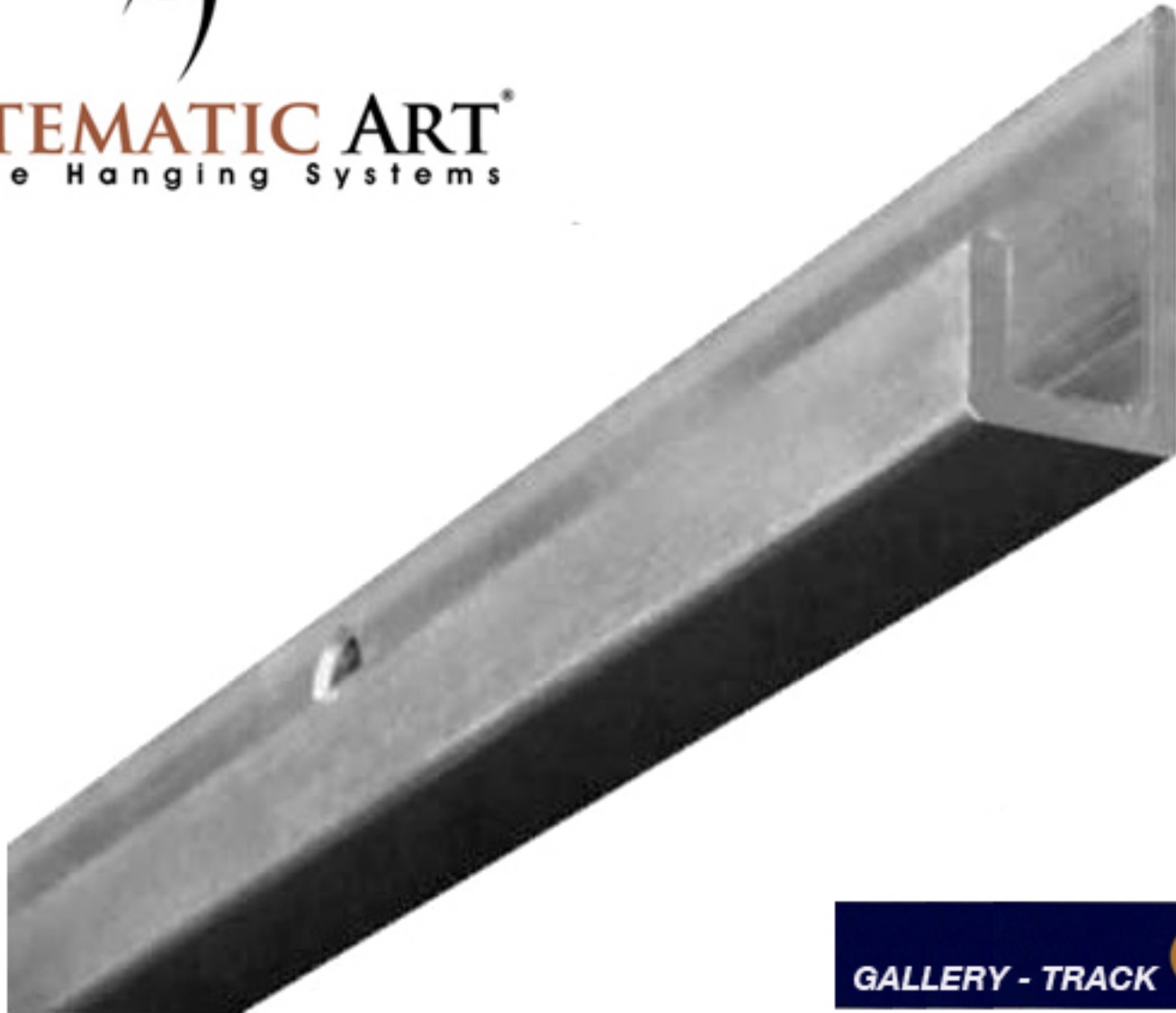

**SYSTEMATIC ART**<sup>®</sup>  
Picture Hanging Systems



**GALLERY - TRACK** **WALL-MOUNTED**

**TOLL FREE 1.888.426.4406**

# How it works

Hanging Rod

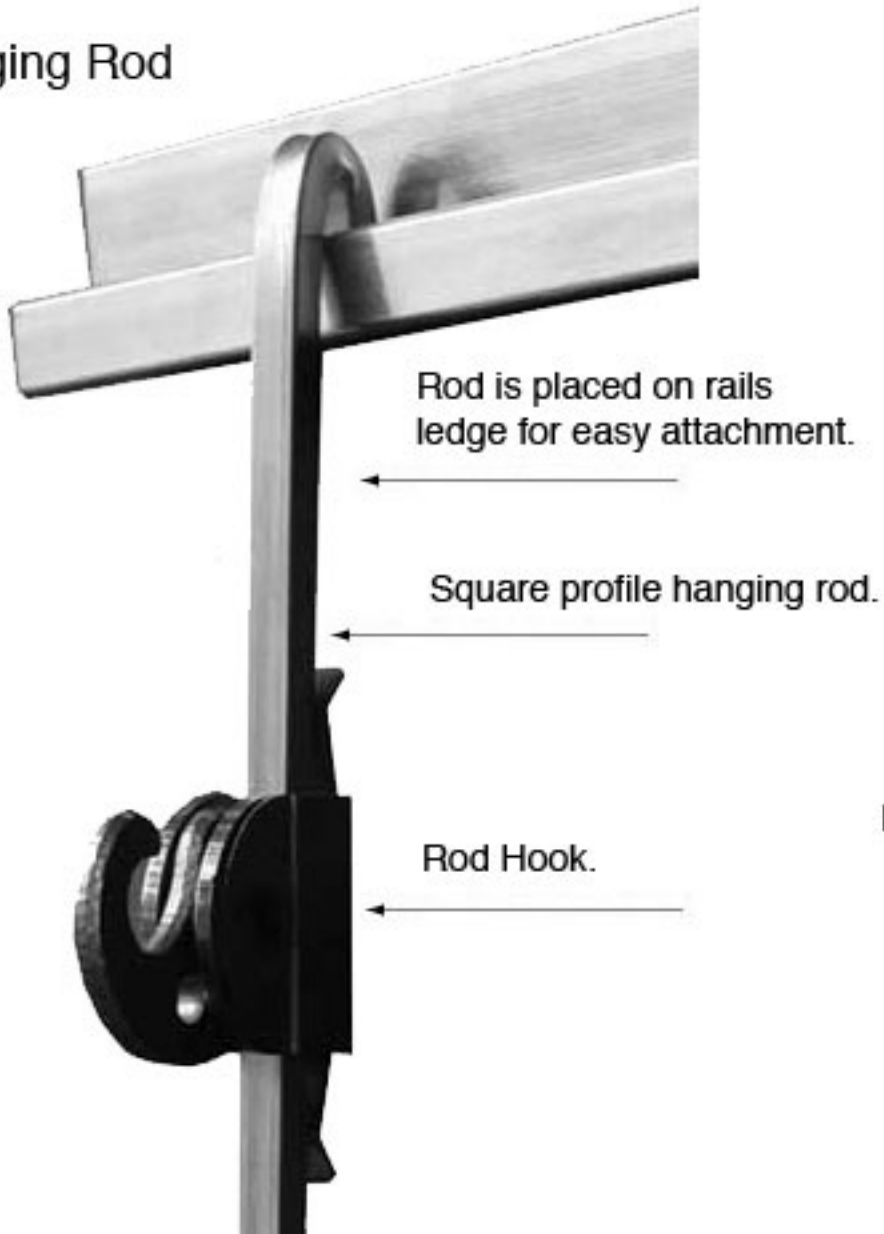

Hanging Cable

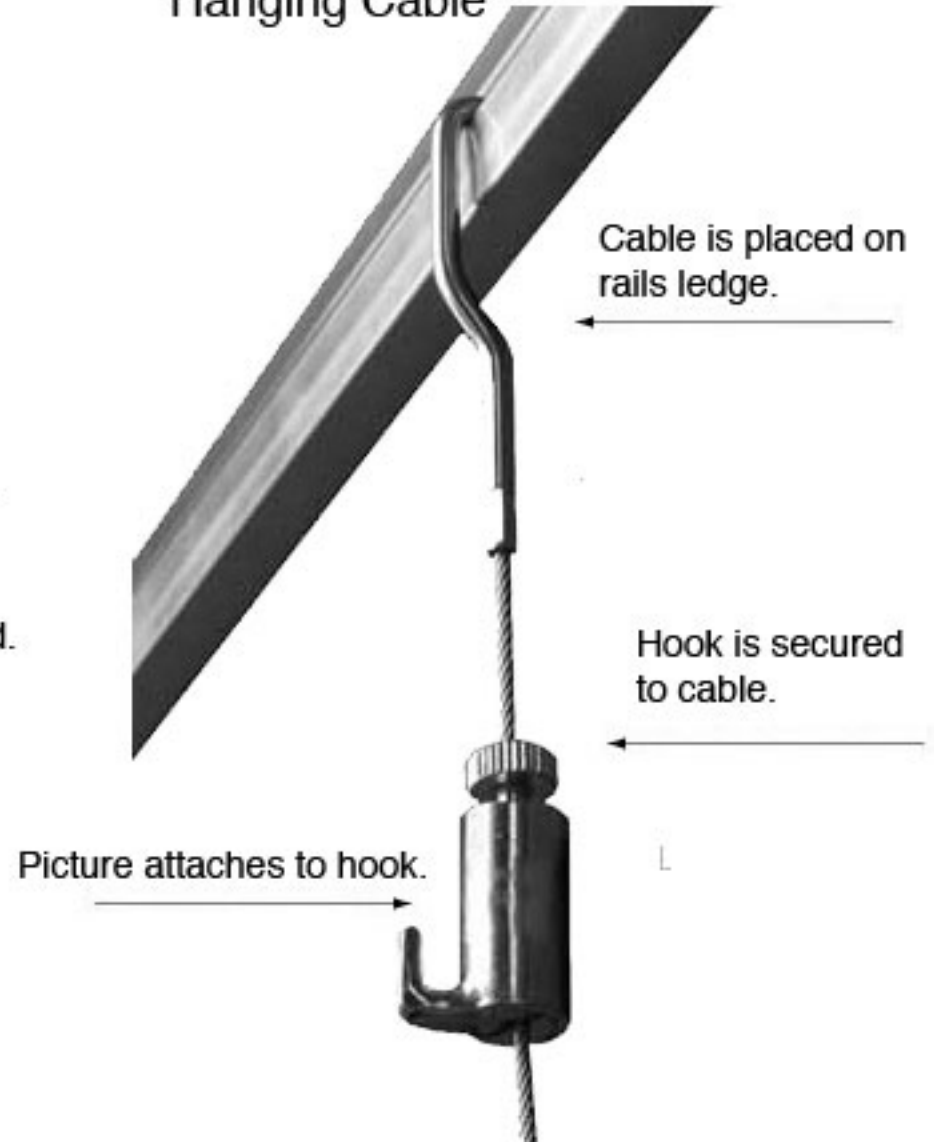



**SYSTEMATIC ART**<sup>®</sup>  
Picture Hanging Systems

## Gallery Rail / Wall - Mounted Specification and Installation

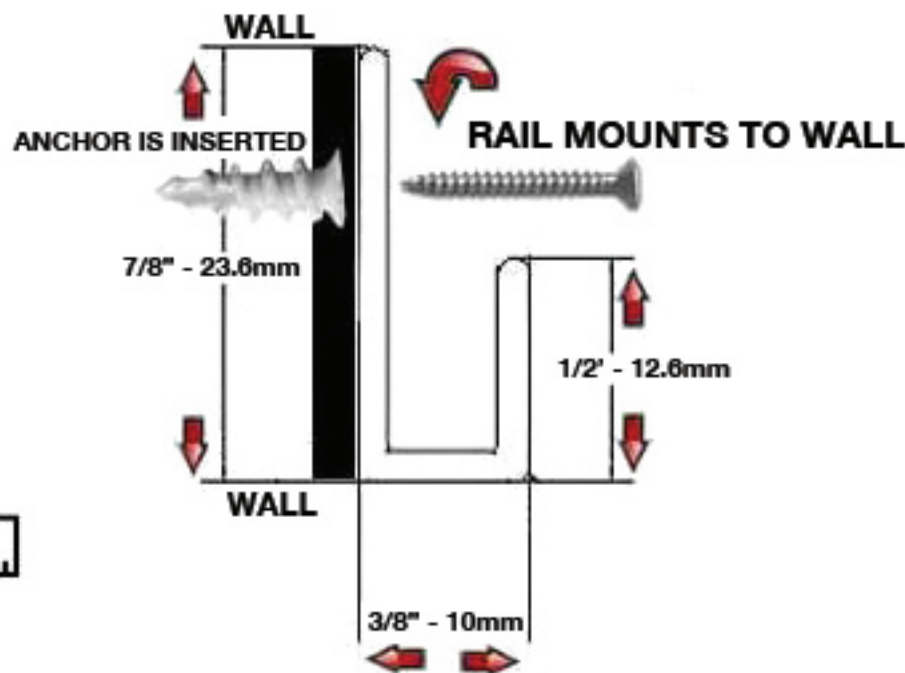

**Required Installation Tools**

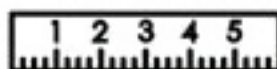

8 pre-drilled Holes

**Proprietary**

The drawings and specifications herein are the property of Systematic Art, LLC. The item contained herein shall not be reproduced, copied or used as a basis for production without express written consent from Systematic Art, LLC

REF: GALLERY RAIL	WM501P
MATERIAL: ALUMINUM	
GALLERY - 8 PRE-DRILLED HOLES	



**SYSTEMATIC ART, LLC**  
14508 Garfield Ave. Paramount, CA 93013  
Main: 212.614.3233 / Facsimile: 212.254.1046

DESCRIPTION:  
**ART-RAIL - ALUMINUM EXTRUDED**  
GALLERY WALL- MOUNTED  
PART NO. WM501P

TOLL FREE: 1.888.426.4406  
[www.SystematicArt.com](http://www.SystematicArt.com)

# Gallery Rail / Wall - Mounted







**SYSTEMATIC ART**<sup>®</sup>  
Picture Hanging Systems

Actual Size Picture



**Available Colors:**

-  Natural / Milled
-  Silver / Anodized
-  White / Semi-Gloss powder coated
-  Black / Anodized

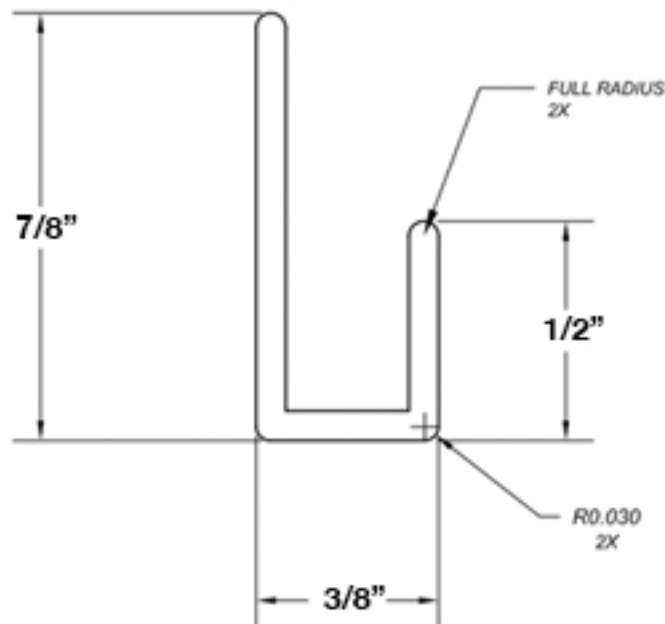

8 pre-drilled Holes

*Proprietary*

The drawings and specifications herein are the property of Systematic Art, LLC. The item contained herein shall not be reproduced, copied or used as a basis for production without express written consent from Systematic Art, LLC.

REF: GALLERY RAIL	WM501P
MATERIAL: ALUMINUM	
GALLERY - 8 PRE-DRILLED HOLES	



**SYSTEMATIC ART, LLC**  
14508 Garfield Ave. Paramount, CA 93013  
Main: 212.614.3233 / Facsimile: 212.254.1046

DESCRIPTION:  
**ART-RAIL - ALUMINUM EXTRUDED**  
GALLERY WALL- MOUNTED  
PART NO. WM501P

TOLL FREE: 1.888.426.4406  
[www.SystematicArt.com](http://www.SystematicArt.com)